

# MORATIZ 2D1S

1126

599

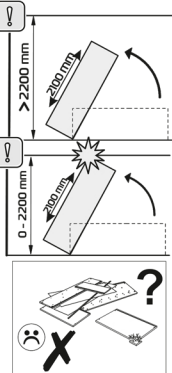
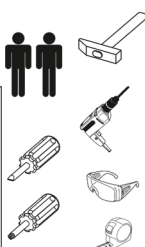
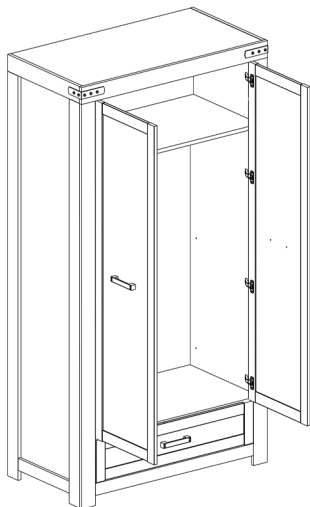
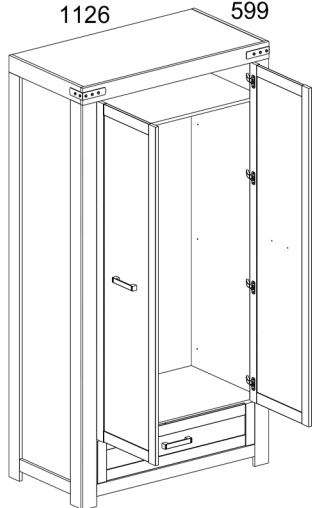

2101

A1	A2	B5	C1	mm
7x34	38	Ø15x12	38	140
D1	E2	H48	I	130
8	8	10x50	1	120
L2	M5	N1	Q	110
500	2	M4x25	6	100
R3	R23	R24	R27	90
3x20	40	6.3x13	16	80
R33	R102	S1	S5	70
4x30	12	3.5x18	44	60
U.1	U5	V8	Y1	50
45x35x15	1	30x36	4	40
Y7	Z27			30
	1	400	1	20
				10

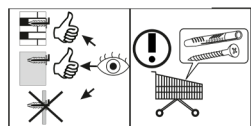
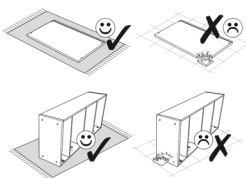
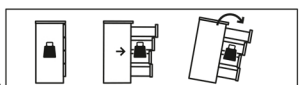

	mm	mm	mm	
5	1088	580	16	1
35	1088	560	16	1
57	1056	560	16	1
58	1056	560	16	1
99	1971	560	16	1
100	1971	560	16	1
137	1126	84	18	1
138	957	60	16	1
147	206	560	16	1
148	206	560	16	1
157	952	210	19	1
178	500	100	16	1
179	500	100	16	1
187	880	100	16	1
209	1684	474	19	2
257	2097	580	18	1
258	2097	580	18	1
290	1991	1082	2,5	1
312	910	505	2,5	1
550	2013	84	18	1
551	2013	84	18	1
Y2	1049			1

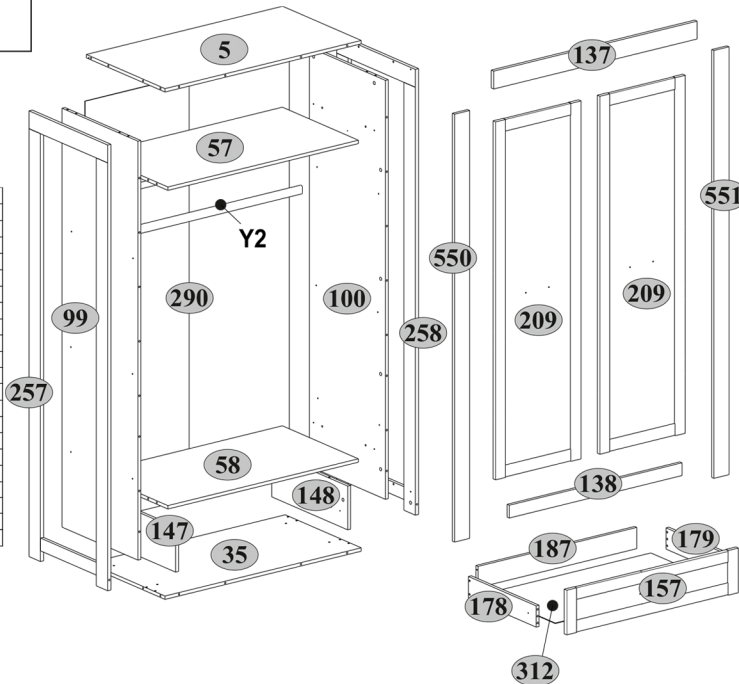

1

A1



7x34

A2



4

Ø15x12

C1

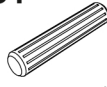

20

8x35

16

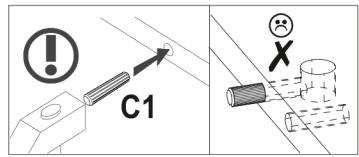
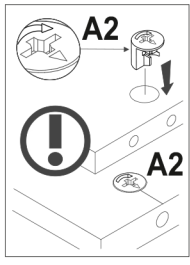
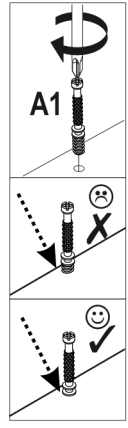
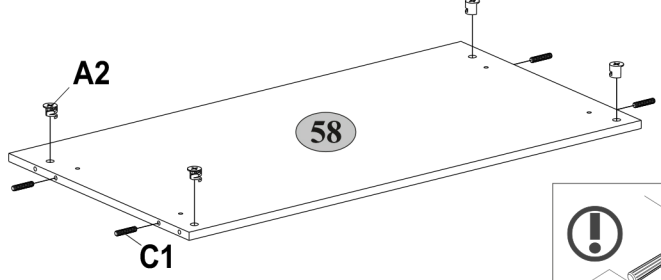
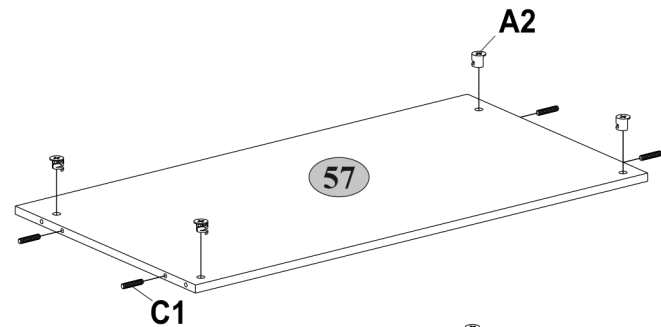
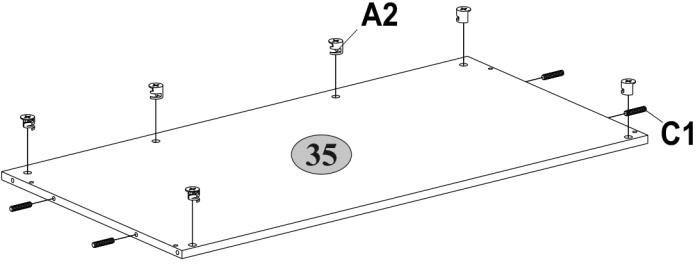
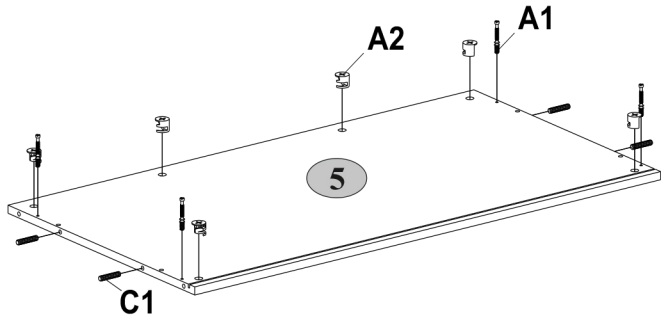

**2****A1**

7x34

**A2**

8 Ø15x12

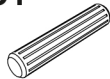
**C1**

12 8x35

**R102**

8 3,5x16

**Y1**

4

2

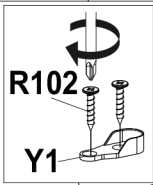
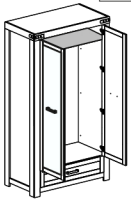
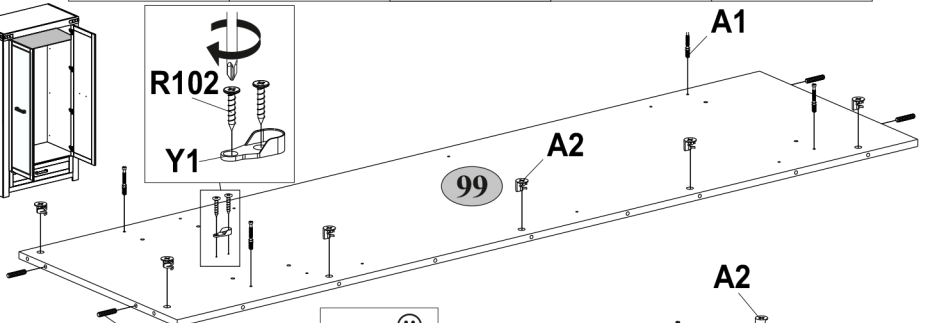
**A1****A2**

99

**A2**

100

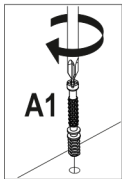
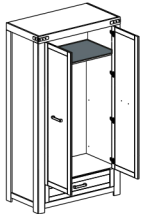
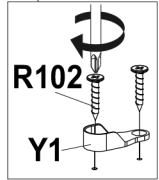
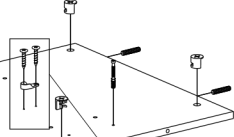
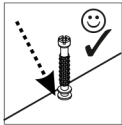
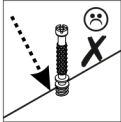
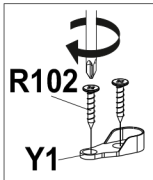
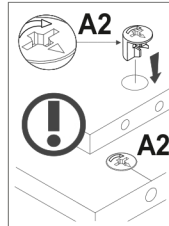
**C1****A1****C1****A1****A2**

99

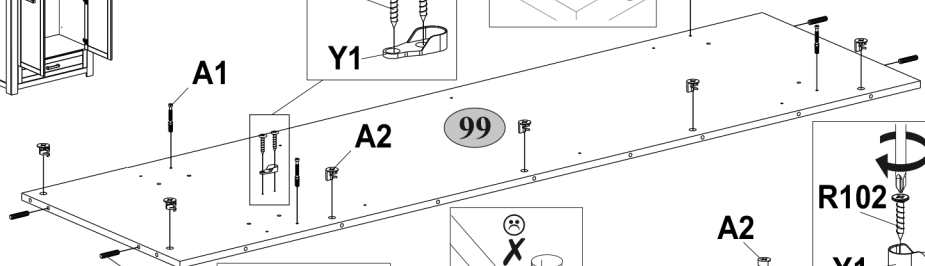
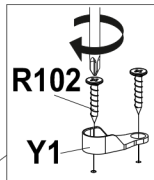
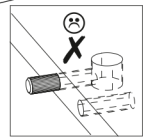
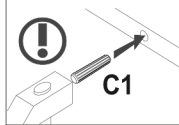
**C1****A1****C1**

100

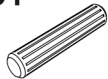
**3****C1**

8x35

**R27**

8 5,0x13

**Z27**

6 400

1

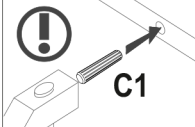
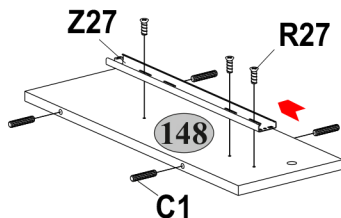
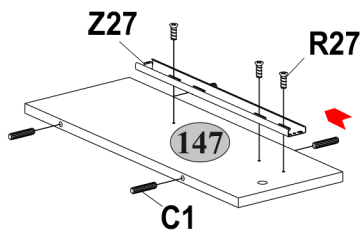
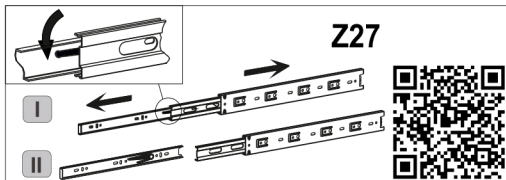
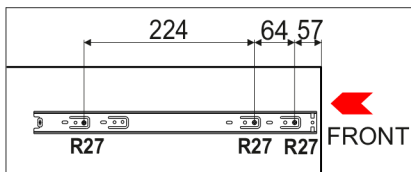
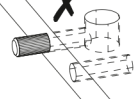
**C1****4****A1**

7x34

**A2**

8 Ø15x12

2

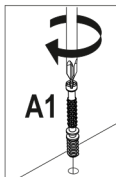
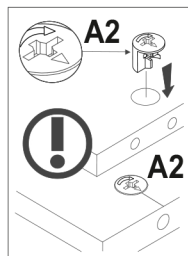
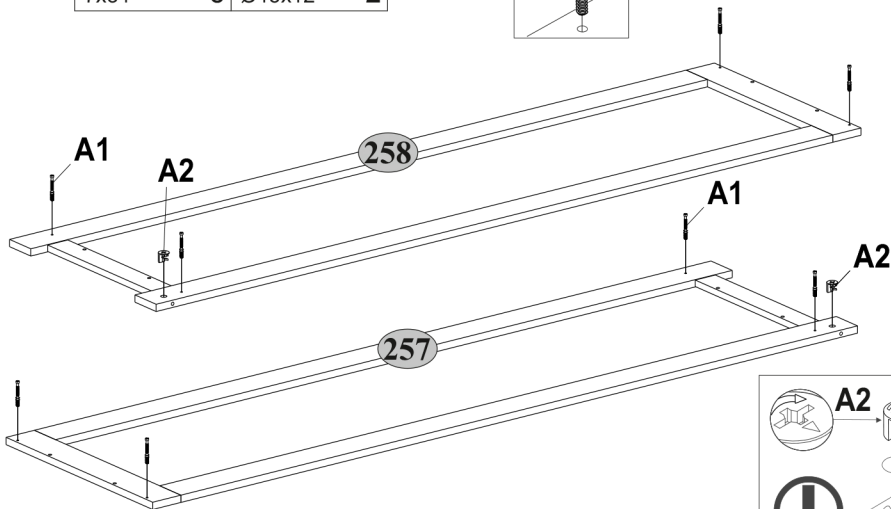
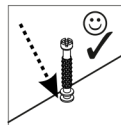
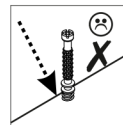
**A1**

5

A1  
7x34 14

D1  
8

R23  
6,3x13 16

R102  
3,5x16 16

U5  
36x36 4

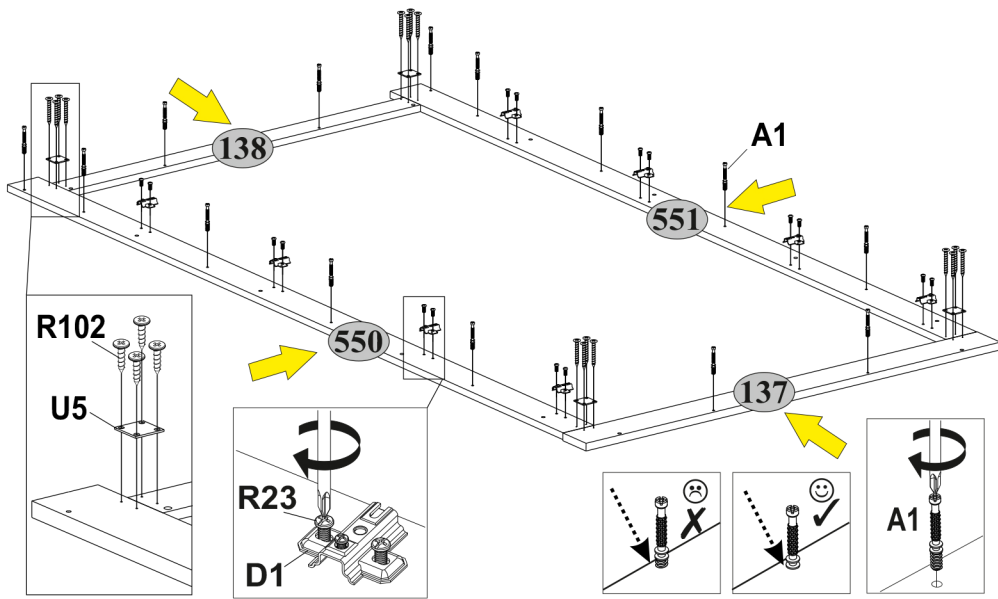

6

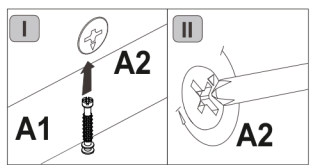
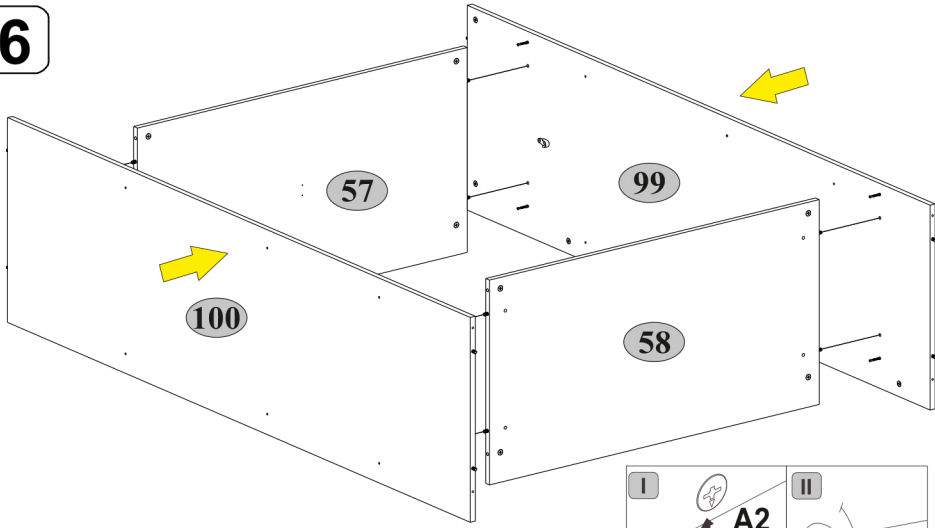

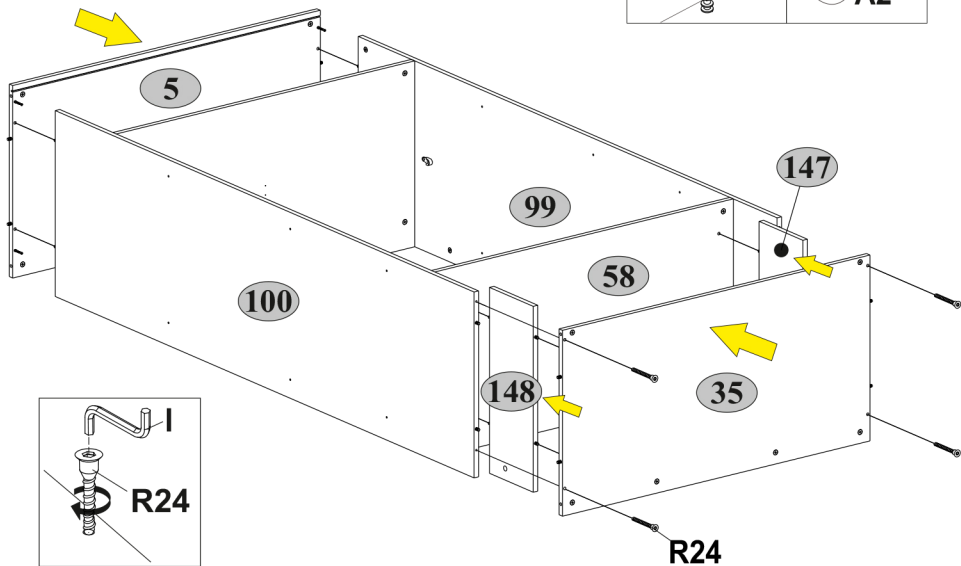
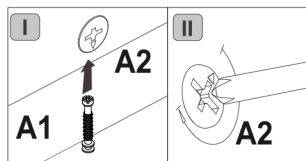
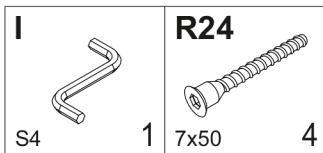
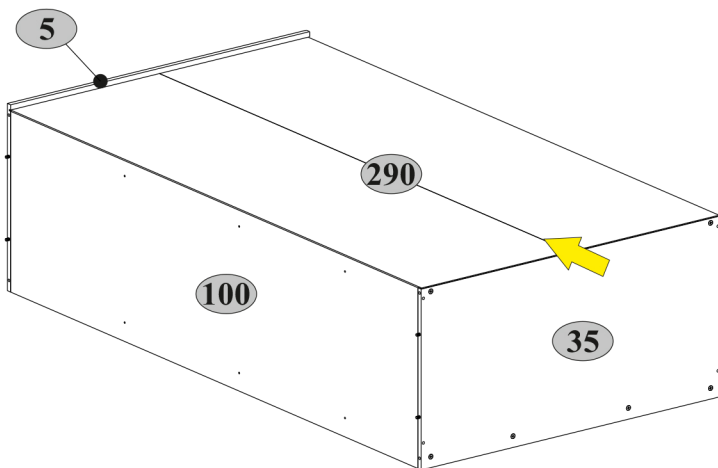
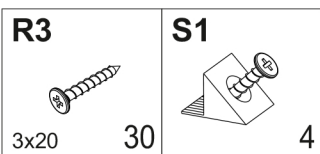
**7****8****I**

II

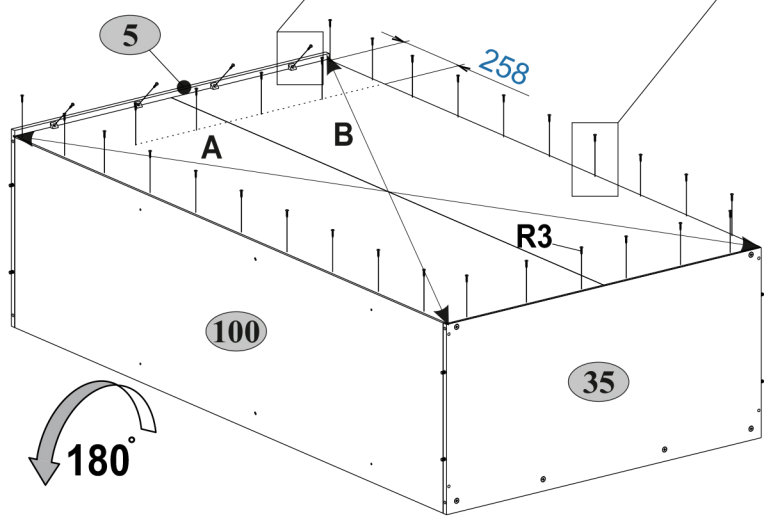
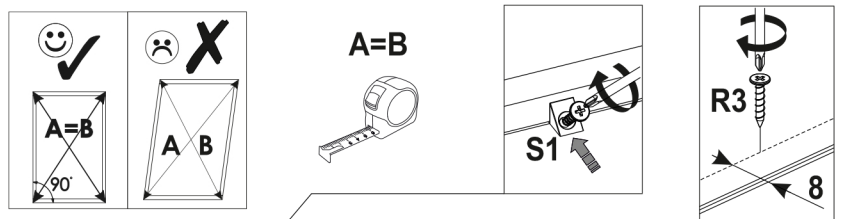

9

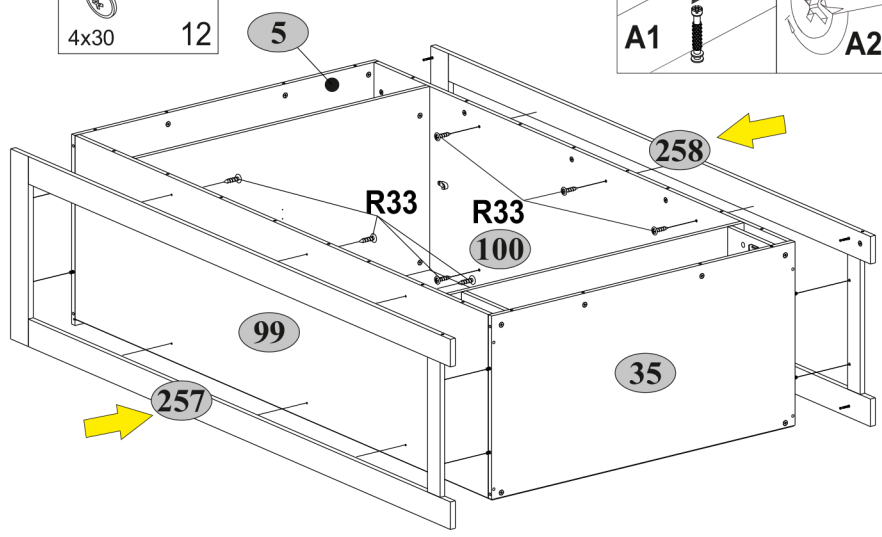
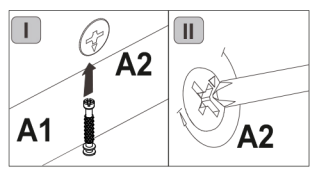
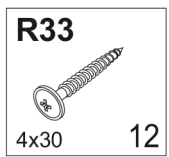

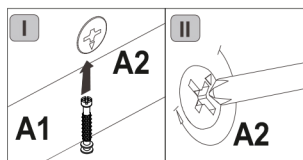
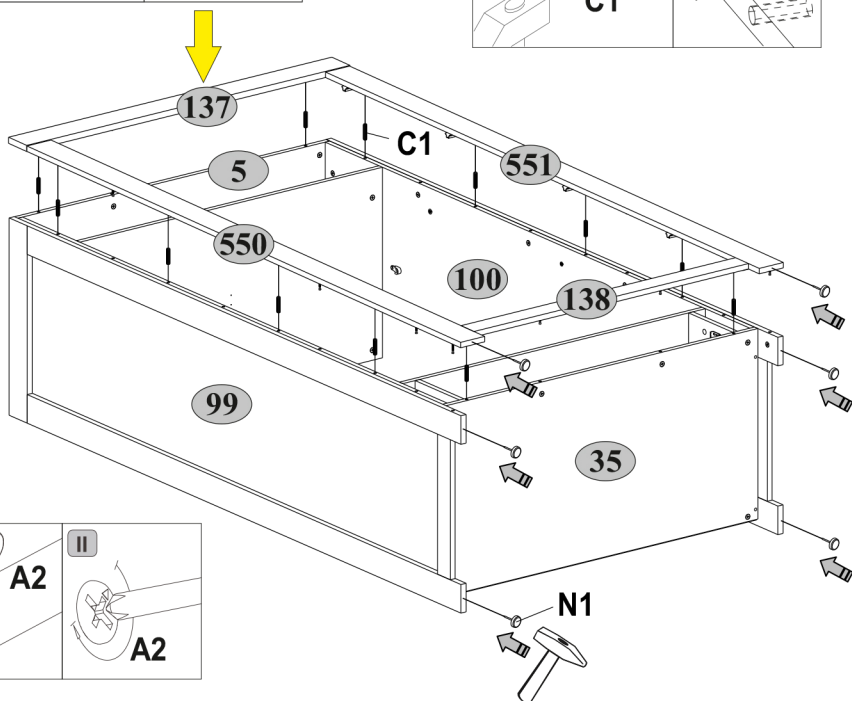
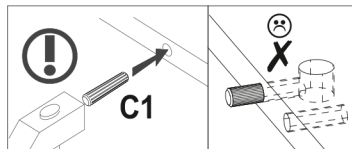
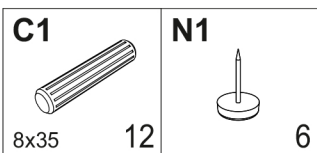
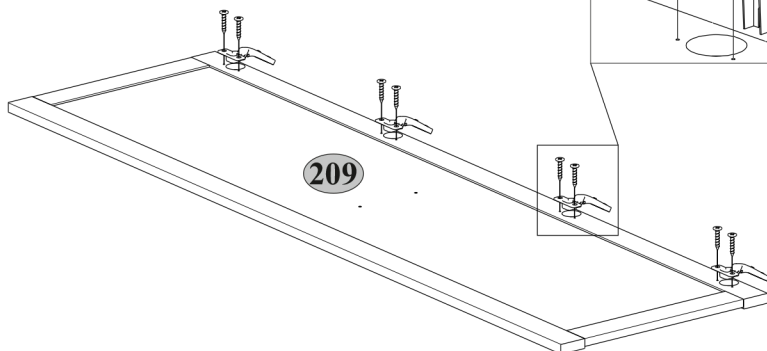
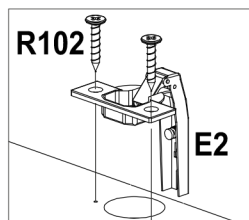
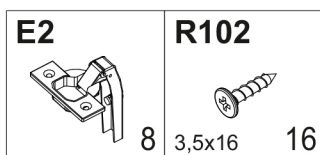

**10****11****x2**

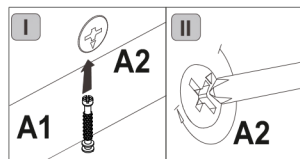
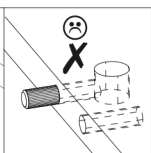
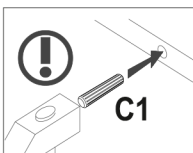
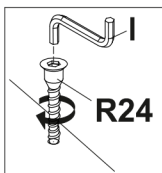
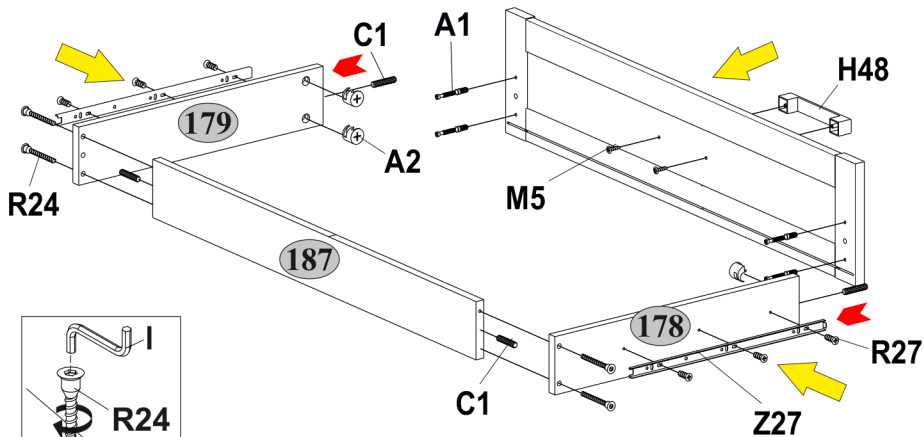
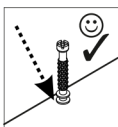
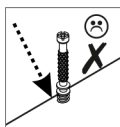
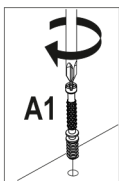
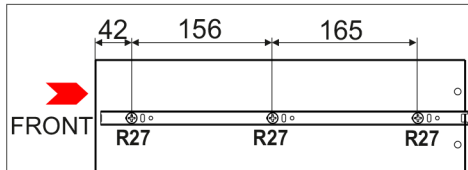
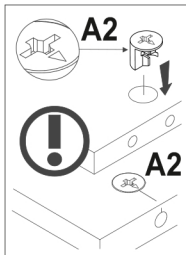
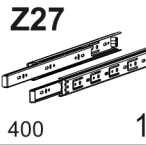
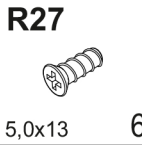
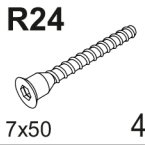
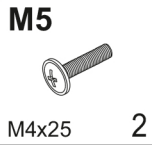
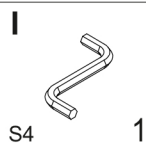
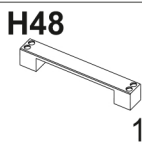
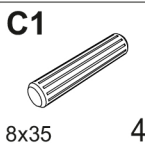
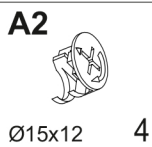
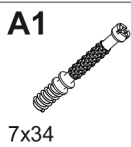

**12**

**13**

<b>L2</b>  500      2	<b>R3</b>  3x20      10	<b>R102</b>  3,5x16      4
---	--	---

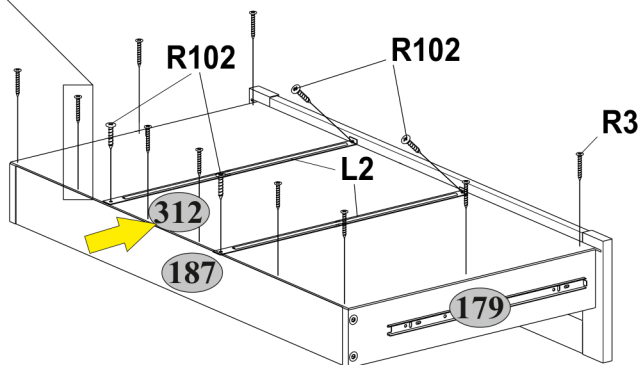
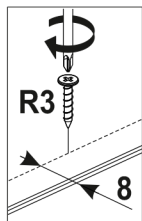
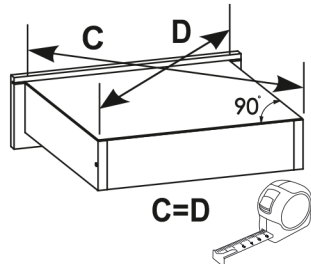

**14****B5**

10x50

1

**R102**

3,5x16

4

**S5**

Ø18

24

**U.1**

45x35x15

1

**Y7**

1

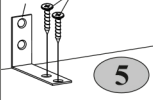
**U.1 R102**

5

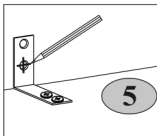

5

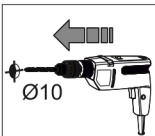

Ø10

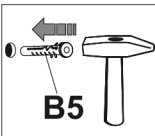
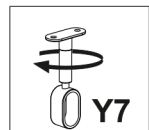
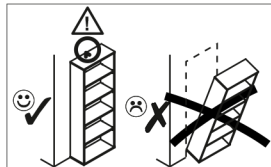
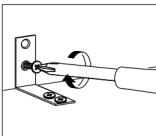
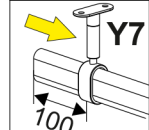
**B5****Y7****Y7**

100

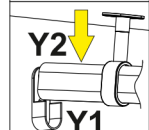
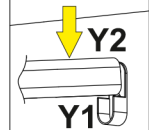
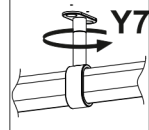
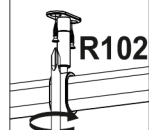
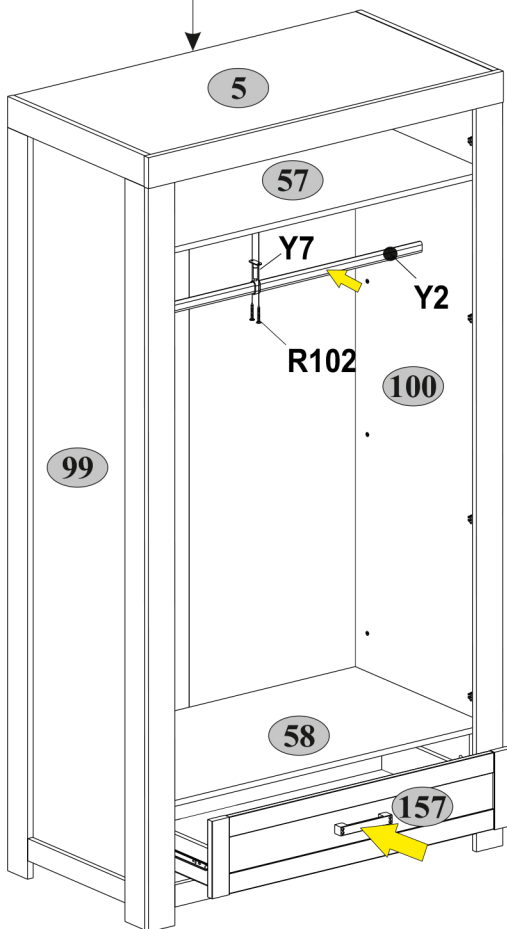
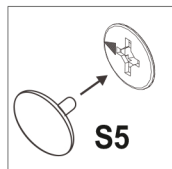
**Y2****Y1****Y2****Y1****Y7****R102**max.  
5 kg**57****58****157**max.  
10 kg**Y2****S5**

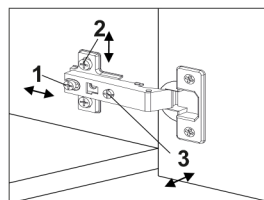
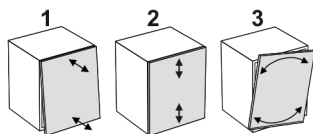
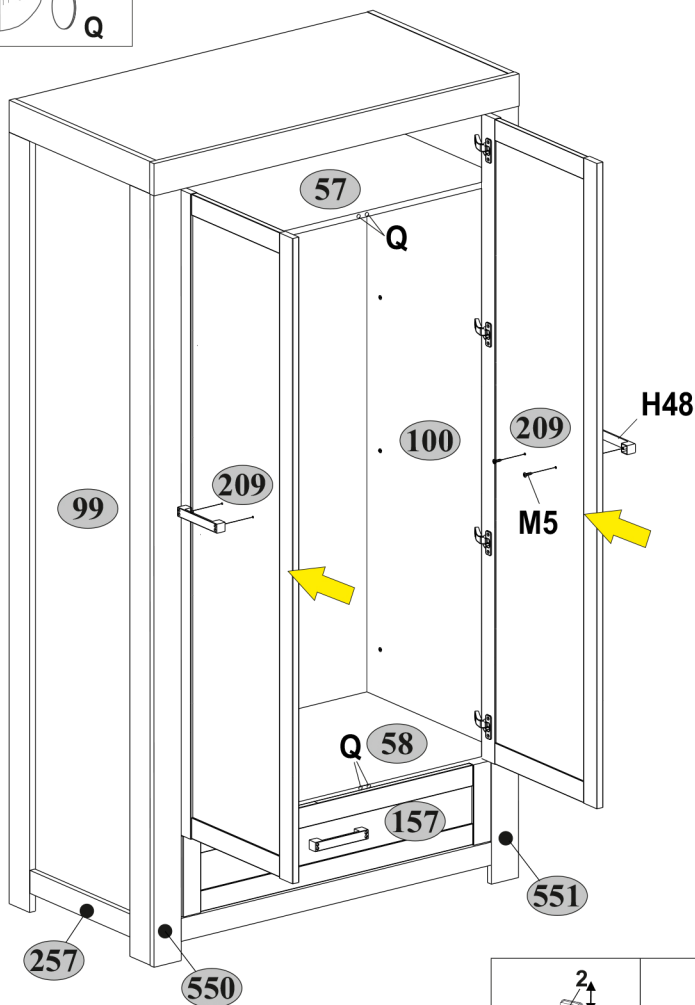
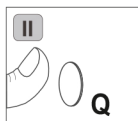
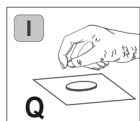
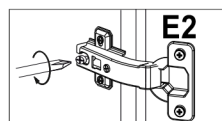
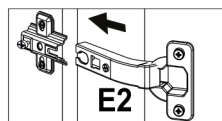
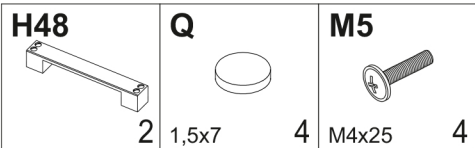
**15**

16

V8

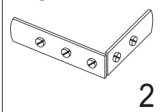

1



2



!



3

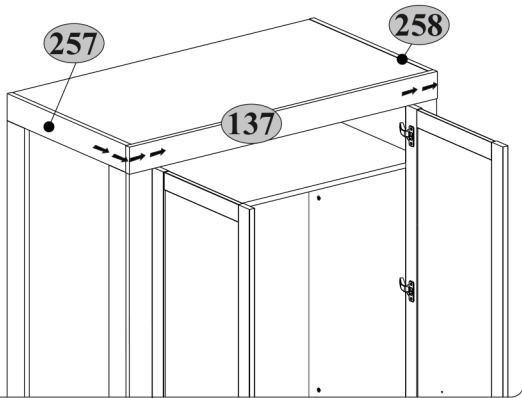

4

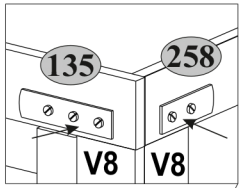
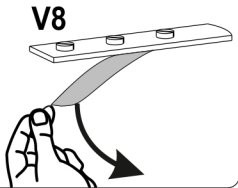
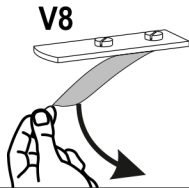

5

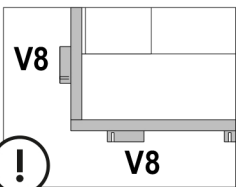
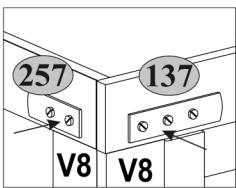

!

